

Absolute Hearing Solutions
614-452-4280

Made for
iPod iPhone iPad



ReSound GN
.....

ReSound ENZO 3D™

User guide





Behind-The-Ear hearing aids

GN Making Life Sound Better

resound.com

Absolute Hearing Solutions

Left Hearing Aid		Right Hearing Aid	
Serial number		Serial number	
Model		Model	
Battery size	<input type="checkbox"/> 675 <input type="checkbox"/> 13		

Program	Beep	Description
1		
2		
3		
4		

614-452-4280 Specific features supported by your aids:

- Smart Start on page 11
- Volume and mute on page 13
- Telecoil on page 19
- Phone Now on page 22
- Direct Audio Input on page 24
- Battery door lock on page 28
- Tinnitus Sound Generator on page 38

Hearing aid type designations for models included in this user guide are:

LO85, FCC ID: X26LO85, IC: 6941C-LO85

LO90, FCC ID: X26LO90, IC: 6941C-LO90

Please see page 62 for a list of models referring to these types.

It may take as long as several months for your brain to get used to all the “new” sounds around you. Following these suggestions will give your brain time to learn how to interpret amplification and increase the benefits you get from using ReSound hearing aids.

1 Introduction

Congratulations on the purchase of your new hearing aids. ReSound’s innovative sound technology and design, combined with the customized programming selected by your hearing care professional, will make hearing a more enjoyable experience.

Please read this manual carefully in order to wholly benefit from the use of your hearing aids. With proper care, maintenance, and usage, your hearing aids will aid you in better communication for many years.

2 Intended use

Generic air-conduction hearing aids are wearable sound-amplifying devices intended to compensate for impaired hearing. The fundamental operating principle of hearing aids is to receive, amplify, and transfer sound to the eardrum of a hearing-impaired person.

3 Becoming accustomed to amplification

While purchasing hearing aids is a major step, it is only one step in a process toward more comfortable hearing. Successfully adapting to the amplification of your hearing aids takes time and consistent use.

You will enjoy more benefits from your ReSound hearing aids by taking the following actions:

Wear the hearing aids regularly in order to get comfortable with using them

- It takes time to get used to hearing aids. Ask your hearing care professional to design a schedule tailored just for you
- As you get more comfortable with your hearing aids, increase the wearing time and wear them in multiple types of listening situations

4 Hearing aid expectations

A hearing aid will not restore normal hearing and will not prevent or improve a hearing impairment resulting from organic conditions. Consistent use of the hearing aid is recommended. In most cases, infrequent use does not permit you to attain full benefit from it.

The use of a hearing aid is only part of hearing rehabilitation and may need to be supplemented by auditory training and instructions in lip-reading.

5 Contents

1	Introduction	4	8.2	Telecoil.....	19	14	ReSound Assist™ (optional)	37	18.1	Phone Now precautions.....	48
2	Intended use	4	8.2.1	Hearing loop systems	20	15	Tinnitus Sound Generator module	38	19	Battery warnings	49
3	Becoming accustomed to amplification	4	8.2.2	HAC telephone	20	15.1	Intended use for TSG module	38	20	Intended use of smartphone apps	49
4	Hearing aid expectations	5	8.3	Phone Now	22	15.2	User instructions for TSG.....	38	21	Important points for FM	50
5	Contents	6	8.3.1	Place the Phone Now magnet.....	22	15.2.1	Description of device.....	38	22	Warning to hearing aid professionals (US only)	51
6	Get to know your hearing aids	8	8.3.2	How to use Phone Now.....	23	15.2.2	Explanation of how the device functions....	38	23	Important notice for prospective hearing aid users (US only)	52
6.1	Your hearing aid - Behind the Ear	8	8.4	Direct Audio Input (optional)	24	15.2.3	The scientific concepts that form the basis for the device	40	23.1	Children with hearing loss (US only)	53
6.1.1	ReSound ENZO 3D, model 88	8	8.4.1	Connect DAI	24	15.2.4	TSG volume control.....	40	24	Technical specifications	54
6.1.2	ReSound ENZO 3D, model 98	9	8.4.2	Disconnect DAI	25	15.2.5	Using TSG with smartphone apps	41	25	Troubleshooting guide	56
6.2	Recognizing left and right hearing aid.....	10	8.4.3	Battery door with integrated DAI.....	26	15.3	Technical specifications	41	26	Statement	60
7	Getting started	11	8.5	Flight mode (optional).....	26	15.3.1	Audio signal technology	41	27	Warranties and repairs	63
7.1	Turn off / Turn on	11	9	Battery door lock	28	15.3.2	Available sounds.....	41	28	Temperature test, transport, and storage information	63
7.1.1	Smart Start.....	11	9.1	ReSound ENZO 3D, model 88	28	15.3.3	Prescription use of a Tinnitus Sound Generator hearing aid	42	29	Advisories	65
7.2	Operation of hearing aid	12	9.2	ReSound ENZO 3D, model 98	29	15.3.4	Important notice for prospective sound generator users.....	43	30	Acknowledgments	66
7.2.1	Program button.....	12	10	Daily maintenance	30	15.4	Tinnitus Sound Generator warnings.....	43			
7.2.2	Volume control.....	13	10.1	Brush (optional).....	31	15.4.1	Tinnitus Sound Generator precautions.....	44			
7.3	Insert/remove hearing aid	14	10.2	Cleaning earmolds.....	32	15.4.2	Tinnitus Sound Generator warning to hearing care professionals.....	44			
7.3.1	Insert earmold	14	10.3	Cleaning metal hook	33	16	General Warnings	46			
7.3.2	Remove earmold.....	15	11	Care and maintenance	34	17	General precautions - Wireless hearing aids	47			
7.4	Insert/replace the battery.....	15	12	Wireless accessories	34	18	Phone Now warnings	48			
7.4.1	Low battery indicator	17	12.1	Using ReSound Smart hearing aids with iPhone, iPad and iPod Touch (optional)	35						
7.4.2	Low battery indicator when paired with wireless accessories.....	17	13	Smartphone apps	36						
8	Telephone use	19	13.1	Using ReSound Smart hearing aids with smartphone apps (optional).....	36						
8.1	Normal use	19									

6 Get to know your hearing aids

6.1 Your hearing aid - Behind the Ear

6.1.1 ReSound ENZO 3D, model 88

1. Program button
2. Volume control
3. Battery door & On/Off switch
4. Sound outlet
5. Microphone inlets
6. Battery door lock and left/right indicator
7. Model
8. Serial number
9. Manufacturer
10. DAI connector
11. Earmold and tubing
12. Earhook

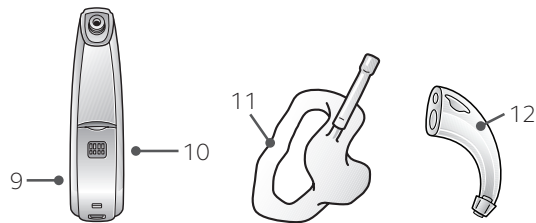
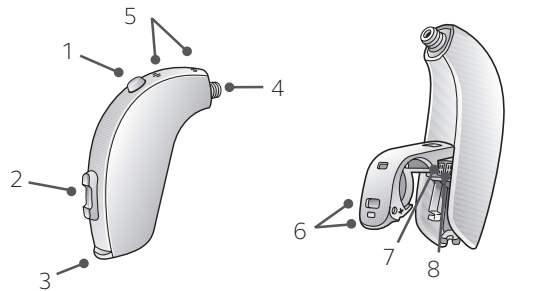

1. Program button
2. Volume control (optional)
3. Battery door lock
4. Battery door & On/Off switch
5. Sound outlet
6. Microphone inlets
7. Left/Right indicator (Left=Blue/Right=Red)
8. Serial number
9. Model
10. Manufacturer
11. Earmold and tubing
12. Earhook

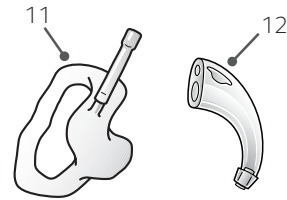
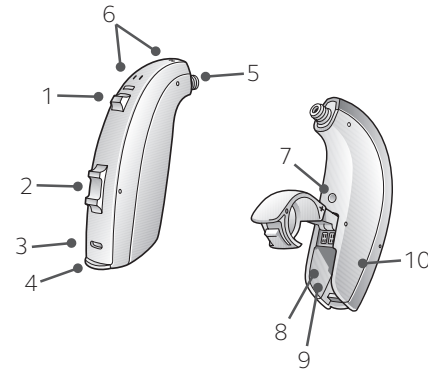

6.2 Recognizing left and right hearing aid

Your hearing aids are individually tuned. Do not swap them. Please pay attention to this when cleaning, storing and inserting your hearing aids.

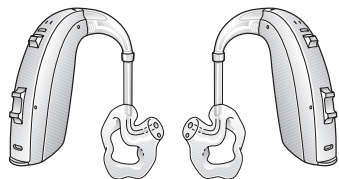

ReSound, model 98 with earmolds.



ReSound, model 88.

Please pay special attention when you attach the earmolds to the hearing aids after cleaning.

CAUTION: TO AVOID MIXING UP THE EARMOLDS AND THE HEARING AIDS, DISASSEMBLE AND CLEAN ONE HEARING AID AT A TIME.

NOTE: Your hearing care professional should mark your hearing aids with a colored Left / Right indication: Left is blue and Right is red.

The hearing aids always start in program 1 and with the pre-set volume.

7.1 Turn off / Turn on

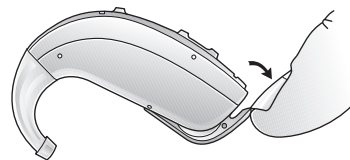

Turn your hearing aid off.

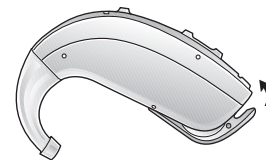

Turn your hearing aid on.

7.1.1 Smart Start

Smart Start delays the time before the hearing aid turns on after you close the battery door. With Smart Start, you will hear a beep (beep etc.) for each second of the delay period (5 or 10 seconds delay).

NOTE: If you want to turn on the hearing aids without delay, ask your hearing care professional to de-activate Smart Start.

7.2 Operation of hearing aid

7.2.1 Program button

Your hearing aid has a push button that allows you to select from up to four different listening programs.

The list on page 2 tells which programs have been enabled.

1. Push the button to change program
2. You will then hear one or more beeps. The number of beeps indicates which program you have selected (one beep = program one, two beeps = program two, etc.)

You can also change programs from some of ReSound's handheld wireless accessories and smartphone apps.

i **NOTE:** If your hearing aids have Synchronized Push Button enabled, changing program on one hearing aid automatically repeats in the second hearing aid. A beep in both hearing aids follows each adjustment.

NOTE: When you turn the hearing aids off and then back on, they always return to program one and pre-set volume.

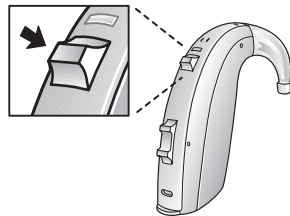

Program button

Your hearing aids automatically adjust the volume depending on your listening situation.

The volume control on the hearing aid may be used to turn the sound level up or down to your preference. You can also adjust the volume from some of ReSound's handheld wireless accessories and smartphone apps. When you change the volume, the hearing aid responds with a beep. When you reach the upper or lower limits, the hearing aid responds with a low-pitched beep.

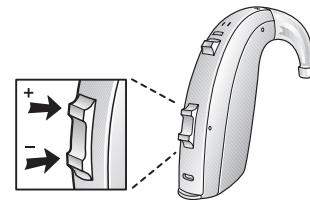

Volume control button.

ReSound ENZO 3D can be programmed with additional function for the volume control on “down button long press”:

- **Minimum volume** - volume will immediately reduce to lowest setting, or
- **Mute** - volume will be muted
- To resume normal volume, “down button long press”

i **NOTE:** If your hearing aids have enabled the Synchronized Volume Control function, volume adjustments to one hearing aid automatically repeat in the other hearing aid. A beep in both hearing aids follows each adjustment.

NOTE: Your hearing care professional can disable the volume control or hide the volume control with a non-functional cover.

7.3 Insert/remove hearing aid

For comfort, always turn off your hearing aids before you insert or remove them.

7.3.1 Insert earmold

1. Hold the earmold between your thumb and index finger and position its sound outlet in your ear canal
2. Slide the earmold all the way into your ear with a gentle, twisting movement
3. Turn the top part of the earmold gently backwards and forwards so that it tucks behind the fold of skin above your ear canal
4. Move the earmold up and down and gently press it to place it correctly in the ear
5. Make sure the hearing aid sits firmly behind the ear

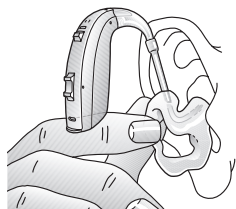

Slide and twist the earmold all the way into the ear canal.

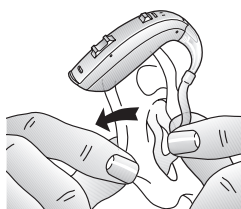

Tuck the earmold behind the fold of skin above the ear canal.



Place the hearing aid firmly behind the ear.



NOTE: It may be helpful to pull your ear up and outward with your opposite hand during insertion.
NOTE: By experimenting, you may discover an easier method.



CAUTION: NEVER ATTEMPT TO MODIFY THE SHAPE OF THE HEARING AID, EARMOLDS, OR TUBING YOURSELF.

7.3.2 Remove earmold

1. Lift the hearing aid from behind the ear
2. Using your thumb and index finger, take hold of the earmold (not the hearing aid or the tubing)
3. Gently, twist and pull the earmold to remove it from the ear

7.4 Insert/replace the battery

1. Prepare the new battery. Remove the protective foil to activate the battery - wait for 2 minutes before inserting the battery into the hearing aid
2. Open the battery door completely by using your fingernail
3. Insert the new battery with the positive side (+) facing upwards. Always insert the battery in the door: never directly into the hearing aid
4. Gently close the battery door

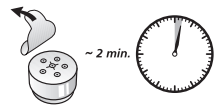

Remove foil and wait two minutes.

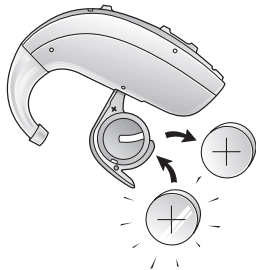

Replace battery.



Please observe the following:

1. Always use new Zinc-Air batteries that have a minimum remaining shelf life of 1 year.
2. To save battery, turn off your hearing aids when they are not in use.
3. At night, switch off the hearing aid and open the battery door completely to allow moisture to evaporate. This prolongs the lifespan of the hearing aid.
4. If the hearing aids frequently lose connection to ReSound wireless accessories, contact your hearing care professional for a list of appropriate batteries.



WARNING: BATTERIES MAY LEAK. REMOVE THE BATTERY IF YOU LEAVE THE HEARING AIDS UNUSED FOR LONGER PERIODS.

WARNING: DO NOT RECHARGE ZINC-AIR BATTERIES - THEY MAY LEAK OR EXPLODE.

WARNING: BATTERIES CONTAIN DANGEROUS SUBSTANCES AND SHOULD BE DISPOSED OF CAREFULLY IN THE INTEREST OF YOUR SAFETY AND FOR THE ENVIRONMENT. ALSO, KEEP BATTERIES AWAY FROM CHILDREN, MENTALLY DISABLED PERSONS, AND PETS.

7.4.1 Low battery indicator

When the batteries are low on power, your hearing aids reduce the volume, and play a melody every 15 minutes until they are empty and turn off.



NOTE: Keep spare batteries on hand.

7.4.2 Low battery indicator when paired with wireless accessories

The batteries drain faster when you use wireless functionalities like streaming from your smartphone or from your TV with our ReSound TV Streamer 2.

As the battery power goes down, the different wireless functions stop working. A short melody every five minutes indicates that battery power is too low.

The table below shows how the functionality shifts with the power level of the battery.

Battery level	Signal	Hearing aid	Remote Control	Streaming
Fully charged		✓	✓	✓
Low		✓	✓	x
Depleted (change battery)		✓	x	x

With a hearing aid you are able to use a phone in a number of ways.

8.1 Normal use

To find the best way to use a telephone or smartphone while wearing your hearing aids may require practice. One or more of the following suggestions may be helpful:

1. Hold the telephone towards the ear (close to the hearing aid's microphone)
2. If whistling occurs, it may take a few seconds of holding the telephone in the same position before the hearing aid eliminates the whistling
3. Whistling may also be stopped by holding the telephone slightly away from the ear



NOTE: Depending on your individual needs, your hearing care professional may activate a program specifically for telephone use.

8.2 Telecoil

Your hearing aids contain a telecoil. The Telecoil program may help to improve speech understanding with Hearing Aid Compatible (HAC) telephones and in theaters, cinemas, houses of worship etc. that have a hearing loop installed.

When you switch on the Telecoil program, your hearing aids pick up signals from the hearing loop or HAC telephone.

Your hearing care professional can activate the Telecoil program.



- NOTE:** The telecoil cannot work without a hearing loop (aka induction-loop) or a HAC telephone.
- NOTE:** If you are having trouble hearing with the hearing loop, ask your hearing care professional to adjust the program.
- NOTE:** If there is no sound from the hearing aids in a hearing loop system and an active Telecoil program, the hearing loop system may not be turned on or is not operating correctly.
- NOTE:** The sound from the hearing loop and the hearing aids' microphones can be mixed to your preference - either during the fitting session or via your smartphone app or your Remote Control 2.

To use the HAC telephone, follow these steps:

1. Switch your hearing aid to the Telecoil program
2. Pick up the telephone and place a call or answer a call
3. Hold the telephone close to the hearing aid, and tilt it slightly outwards
4. Listen to the dial tone and move the telephone to get the best reception
5. If needed, adjust the volume
6. When you hang up, switch to your preferred program

8.2.1 Hearing loop systems

To use hearing loop systems, follow these steps:

1. Switch your hearing aid to the Telecoil program
2. Find a good spot. Reception is not clear in all locations; it depends on the hearing loop. Look for signs or find another spot to sit
3. If needed, adjust the volume
4. When you leave, switch to your preferred program

8.2.2 HAC telephone

Some smartphones are hearing aid compatible (HAC) - others are not. The HAC phone establishes a small hearing loop that your hearing aids connect to.

Switch to the Telecoil program if you want to use a HAC phone.

The telecoil picks up the HAC telephone's signal and converts it to sound.



NOTE: If the phone has a poor telecoil signal, use the microphone program. To avoid whistling, do not hold the handset too tightly against your ear.

NOTE: Ask your hearing care professional to enable the Telecoil program in your hearing aids.

NOTE: If you see a "M3", "M4", "T3", or "T4" on the box, then the smartphone is HAC compliant.

NOTE: If you find it difficult to obtain a good result while using your smartphone, your hearing care professional will be able to give you advice on available wireless accessories to enhance listening capabilities.

NOTE: Ask your smartphone dealer or hearing care professional for advice regarding HAC smartphones.



WARNING: IF A MAGNET IS SWALLOWED, SEEK IMMEDIATE ADVICE FROM A MEDICAL PRACTITIONER.



NOTE: Ask your hearing care professional to enable Phone Now as one of your programs.

NOTE: Do not cover the loudspeaker opening with the magnet.

NOTE: If Phone Now does not work to your satisfaction, moving the magnet to another position may improve ease of use and comfort while speaking.

NOTE: If the hearing aids do not switch to the telephone program every time, you can reposition the Phone Now magnet or add additional magnets.

NOTE: Use a recommended cleaning agent to clean the telephone.

8.3 Phone Now

By placing a magnet on the telephone receiver, your hearing aids automatically switch the telephone program on when the receiver is close to your ear.

When you remove the receiver from your ear, the hearing aids automatically return to the previous listening program.

 **NOTE:** Ask your hearing care professional to enable Phone Now as one of your programs.

8.3.1 Place the Phone Now magnet

Follow these steps in order to place the Phone Now magnet properly:



Clean the telephone thoroughly.

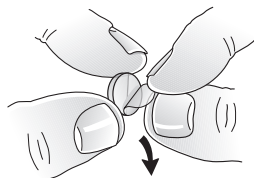

Remove foil from magnet.

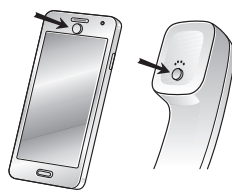

Place the magnet.

8.3.2 How to use Phone Now

1. Lift the telephone to your ear
2. When you hear a short melody, the phone program is active



NOTE: You may need to move the telephone receiver slightly to find the best position for reliable Phone Now activation and good hearing on the telephone.

NOTE: If your hearing aids have enabled Comfort Phone functionality, the hearing aid on the non-phone ear automatically attenuates.

8.4.1 Connect DAI

1. Align the tip of the DAI click-on adapter with the groove above the battery door
2. Once in place, move the click-on adapter in the direction of the battery door
3. Gently click the DAI click-on adapter onto the hearing aid

8.4 Direct Audio Input (optional)

You can connect a DAI boot accessory to the bottom of the hearing aids. Once properly clicked into place, the hearing aids automatically switch to DAI (Direct Audio Input).

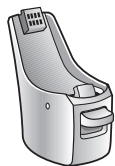

Direct Audio Input adapter

The sound source is connected to the hearing instruments by a cable or a wireless FM system¹ to the audio boot.

To improve spatial sense and being able to hear colleagues, fellow students etc., the DAI input can be mixed with the microphone input.



NOTE: Using the DAI functionality results in increased battery consumption.

¹ The FM receiver is compatible with all FM systems. The FM frequency may vary from country to country. Ask your hearing care professional for advice when going abroad.

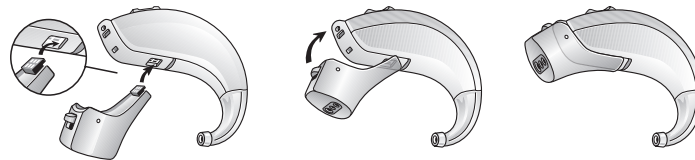

Attaching the DAI click-on adapter to ReSound ENZO 3D, model 88.

8.4.2 Disconnect DAI

1. Slide the latch downwards with your fingernail
2. Gently remove the click-on adapter from the hearing aid

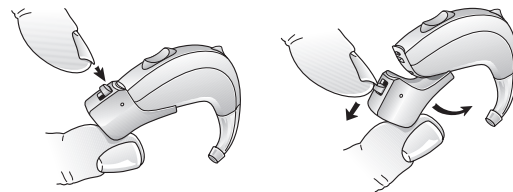

Remove the DAI click-on adapter from ReSound ENZO 3D, model 88.

8.4.3 Battery door with integrated DAI

Your hearing care professional can replace the standard battery door with an integrated DAI battery door.

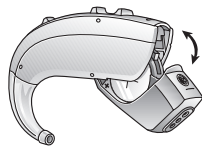

Battery door with integrated DAI on ReSound ENZO 3D, model 98.

Select the DAI program either via the program button or via one of our wireless accessories.

i **NOTE:** Not all models support the integrated battery door solution. Ask your hearing care professional for more information.

NOTE: Using the DAI functionality results in increased battery consumption.

8.5 Flight mode (optional)

! **WARNING:** WHEN BOARDING A FLIGHT OR ENTERING AN AREA WHERE RF TRANSMITTERS ARE PROHIBITED, WIRELESS FUNCTIONALITY MUST BE DEACTIVATED.

Follow these steps to turn on Flight mode:

1. For each hearing aid, open and close the battery door three times within a 10-second period close (open-close, open-close, open-close)
2. Double-dings for ten seconds (🎵🎵🎵 etc.) indicate that your hearing aid is in Flight mode, i.e. you cannot control it remotely

Follow these steps to de-activate Flight mode:

1. For each hearing aid, open and close the battery door once
2. Single dings for ten seconds (🔔🔔🔔 etc.) indicate that your hearing aid is in wireless mode



NOTE: Both hearing aids must be set in Flight mode - even with synchronization enabled.

NOTE: It is important to wait an additional 15 seconds after wireless function resumes before opening and closing the battery door again for any reason. Flight mode will resume if you open and close the battery door during this 15-second window.

9 Battery door lock

Your hearing aid can be equipped with a lock on the battery door. Once you lock the battery door, you can turn the hearing aid on and off. You have to unlock the battery door to replace the battery.

 **NOTE:** Children and mentally disabled persons may benefit from a safer battery door lock system. Ask your hearing care professional for advice.

9.1 ReSound ENZO 3D, model 88

Use the tool to lock or unlock the battery door.
To lock the battery door:



Open the battery door to the OFF position.

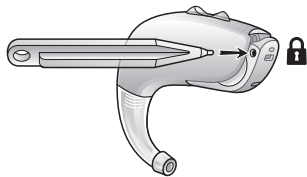

From the left side, push the slider to the right.

Absolute Hearing Solutions

614-452-4280 To unlock the battery door (to replace the battery):

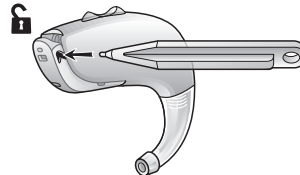

Open the battery door to the OFF position. From the right side, push the slider to the left.

Now, open the battery door completely to replace the battery.

9.2 ReSound ENZO 3D, model 98

To lock or unlock the battery door, use the accompanying tool:
To lock the battery door

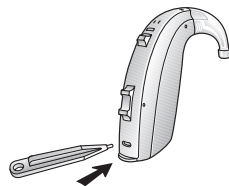

Insert tool straight into battery door lock.

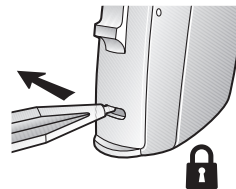

Slide lock to the left.



Indication mark shows "lock" position - white dot appears.

To unlock the battery door (to replace the battery):

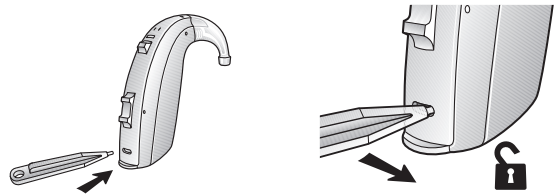

Insert tool straight into battery door lock.

Slide the lock to the right.



Open the battery door completely to replace the battery.

10 Daily maintenance

It is important to keep your hearing aid clean and dry.

On a daily basis, clean the hearing aids using a soft cloth or tissue.

If the microphone inlets are clogged, gently brush across the microphone inlets with a small, clean brush.



WARNING: DO NOT USE FORCE TO PRESS THE HAIRS OF THE BRUSH INTO THE INLETS, BECAUSE THE MICROPHONES MAY BE DAMAGED.

CAUTION: DO NOT USE ALCOHOL OR OTHER SOLVENTS TO CLEAN YOUR HEARING AIDS; THE PROTECTIVE COATING WILL BE DAMAGED.

10.1 Brush (optional)

Use the three-in-one brush for daily cleaning and battery handling.

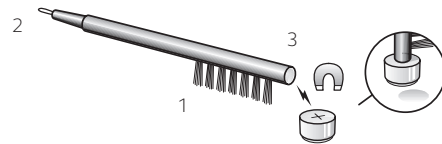

1. Brush - cleaning: Use the brush on all surfaces and orifices
2. Wire loop - cleaning: Use the wire loop to clean the earmould
3. Magnet - battery handling: Use the magnet to lift and replace the battery



NOTE: Do not use the wire loop to clean the microphone openings. If the microphone openings clog up, visit your hearing care professional.

NOTE: The wire loop is only intended for BTE earmoulds.

10.2 Cleaning earmolds

1. Detach the earmold and tubing from the hearing aid before cleaning
2. Use a mild soap to clean the earmold and rinse with lukewarm water
3. Dry the earmold thoroughly. Use the airbulb and cleaning wire to remove residual water and debris from the tubing

 **NOTE:** Use the hook to remove wax etc.
NOTE: We recommend that you change the tube every three months or sooner if it gets stiff or brittle.

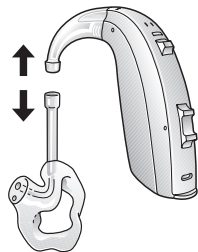

Pull the earmold and device apart.



Use air bulb to remove residual water.

10.3 Cleaning metal hook

1. Remove the earmold and tubing from the metal hook
2. Use a damp cloth to wipe the metal hook

 **NOTE:** Do not use alcohol or other cleaning solvents to clean the metal hook as this could damage its protective covering.

ReSound Phone Clip+ streams phone conversations and stereo sound directly to both hear-ing aids, and it doubles as a simple remote control.

ReSound Micro Mic is a body worn microphone for your friend or colleague. It significantly improves speech understanding in noisy situations.

ReSound Multi Mic works like the Micro Mic but doubles as a table microphone. Connects with loop and FM systems², and has a mini-jack input for streaming audio from a computer or music player



NOTE: Ask your hearing care professional for more information on the range of ReSound wireless accessories.

NOTE: For use of wireless functionality only use ReSound wireless accessories. For further guidance regarding e.g. pairing, please refer to the user guide of the relevant ReSound wireless accessory.

12.1 Using ReSound Smart hearing aids with iPhone, iPad, and iPod touch (optional)

ReSound ENZO 3D is Made for iPhone, and allows for direct communication and control with an iPhone, iPad, or iPod touch.



NOTE: For assistance with pairing and using these products with your ReSound hearing aids, please contact your hearing care professional or visit our support site at www.resound.com.

² Requires an FM receiver.

11 Care and maintenance

Please follow the advices below to have the best user experience and to prolong the life of your hearing aids.

1. Keep your hearing aids dry and clean.
2. Open the battery door to dry out your hearing aids when you are not wearing them.
3. Wipe the hearing aids with a soft cloth after use to remove grease or moisture.
4. Do not wear your hearing aids when putting on cosmetics, perfume, after-shave, hair spray, sun-tan lotion etc. These might discolor the hearing aid or get into the hearing aid causing damage.
5. Do not immerse your hearing aid in any liquid.
6. Keep your hearing aids away from excessive heat and direct sunlight. The heat may deform the shell, damage the electronics and deteriorate the surfaces.
7. Do not swim, shower or steam bathe while wearing your hearing aids.

12 Wireless accessories

ReSound's wireless eco-system features a comprehensive range of seamlessly integrated wireless accessories. This allows you to control and stream high quality stereo sound and speech directly to your hearing aids.

Please find the list of available wireless accessories below:

ReSound TV Streamer 2 allows you to stream the audio from TV sets and virtually any other audio source to your hearing aids at a volume level that suits you.

ReSound Remote Control 2 allows you to adjust the volume or mute your hearing aids, change programmes, and see all your settings at a glance on its crystal clear display.

13 Smartphone apps

The app must only be used with ReSound hearing aids for which they are intended, and ReSound takes no responsibility if the app is used with other hearing aids.

13.1 Using ReSound Smart hearing aids with smartphone apps (optional)

- Do not disable app notifications.
- Install updates to keep the app working correctly.



NOTE: For assistance with pairing and using these products with your ReSound hearing aids, please contact your hearing care professional or visit our support site at www.resound.com.

NOTE: If you have a Bluetooth enabled Android³ smartphone, you are able to answer the telephone if you use ReSound Phone Clip+.

14 ReSound Assist™ (optional)

If you sign up to use the ReSound Assist service available with your hearing aids, your hearing aids can be adjusted remotely.

Ask your hearing care professional for more information.

³ For a complete list of compatible Android products, ask your hearing care professional.

Modulation level and speed can also be configured to your likes and needs. An additional feature can be enabled by your hearing care professional that allows you to select predefined sounds that simulate sounds from nature, such as breaking waves or running water.

If you have two wireless hearing aids that support ear-to-ear synchronization this functionality can be enabled by your hearing care professional. This will cause the Tinnitus Sound Generator to synchronize the sound in both hearing aids.

If your tinnitus troubles you only in quiet environments, your doctor, audiologist or hearing care professional can set the TSG module so that it becomes audible exclusively in such surroundings. The overall sound level can be adjusted via an optional volume control. Your doctor, audiologist or hearing care professional will review with you the need for having such a control.

For hearing aids where ear to ear synchronization is enabled, your hearing care professional can also enable environmental monitoring synchronization so that the TSG noise level is automatically adjusted simultaneously in both hearing aids dependent on the background sound level. Additionally, if the hearing aid has a volume control, then the background noise level monitored by the hearing aid and the volume control can be used simultaneously to adjust the generated noise level in both hearing aids.

15 Tinnitus Sound Generator module

15.1 Intended use for TSG module

Your ReSound hearing aid includes the Tinnitus Sound Generator (TSG) module, a tool for generating sounds to be used in tinnitus management programs to relieve suffering from tinnitus.

The TSG can generate sounds adjusted to the specific therapeutic needs and your personal preference as determined by your doctor, audiologist, or hearing care professional.

Depending on the selected hearing aid program and the environment you are in, you will sometimes hear the therapeutic sound resembling a continuous or fluctuating noise.

15.2 User instructions for TSG

15.2.1 Description of device

The Tinnitus Sound Generator (TSG) Module is a software tool that generates sounds to be used in tinnitus management programs to relieve suffering from tinnitus.

15.2.2 Explanation of how the device functions

The TSG module is a frequency and amplitude shaped white-noise generator. Noise signal level and frequency characteristics can be adjusted to the specific therapeutic needs as determined by your doctor, audiologist or hearing care professional.

Your doctor, audiologist or hearing care professional can modulate the generated noise with the purpose of making it more pleasant. The noise can then resemble, for example, crashing waves on a shore.

15.2.3 The scientific concepts that form the basis for the device

The TSG module provides sound enrichment with the aim of surrounding the tinnitus sound with a neutral sound, which is easily ignored. Sound enrichment is an important component of most approaches to tinnitus management, such as Tinnitus Retraining Therapy (TRT).

To assist habituation to tinnitus, this needs to be audible. The ideal level of the TSG module, therefore, should be set so that it starts to blend with the tinnitus, and so that you can hear both your tinnitus as well as the sound used.

In a majority of instances, the TSG module can also be set to mask the tinnitus sound, so to provide temporary relief by introducing a more pleasant and controllable sound source.

15.2.4 TSG volume control

The sound generator is set to a specific loudness level by the hearing healthcare professional. When switching the sound generator on, the volume will have this optimal setting. Therefore, it might not be necessary to control the volume (loudness) manually.

However, the volume control provides the ability to adjust the volume, or amount of stimulus, to the liking of the user.

The volume control is an optional feature in the TSG module used for adjusting the sound generator output level. To prevent unintended usage by pediatric or physically or mentally challenged users, the volume control must, if enabled, be configured to only provide a decrease of the sound generator output level.

15.2.5 Using TSG with smartphone apps

The tinnitus sound generator control via hearing aid push buttons can be enhanced with wireless control from a TSG control app on a smartphone or mobile device. This functionality is available in supported hearing aids when a hearing healthcare professional has enabled the TSG functionality during fitting of the hearing aid.

To use smartphone apps the hearing aid must be connected with the smartphone or mobile device.



NOTE: To use smartphone apps, the hearing aid must be connected with the smartphone or mobile device.

15.3 Technical specifications

15.3.1 Audio signal technology

Digital.

15.3.2 Available sounds

White noise signal which can be shaped with the following configurations:

The white noise signal can be modulated in amplitude with an attenuation depth of up to 14dB.

High-pass filter	Low-pass filter
500 Hz	2,000 Hz
750 Hz	3,000 Hz
1,000 Hz	4,000 Hz
1,500 Hz	5,000 Hz
2,000 Hz	6,000 Hz

15.3.3 Prescription use of a Tinnitus Sound Generator hearing aid

The TSG module should be used as prescribed by your doctor, audiologist or hearing healthcare professional. In order to avoid permanent hearing damages, the maximum daily usage depends on the level of the generated sound.

Should you develop any side effects from using the sound generator, such as dizziness, nausea, headaches, perceived decrease in auditory function or increase in tinnitus perception, you should discontinue use of sound generator and seek medical evaluation.

The target population is primarily the adult population over 18 years of age. This product may also be used with children 5 years of age or older. However, children and physically or mentally challenged users will require training by a doctor, audiologist, hearing healthcare professional or the guardian for the insertion and removal of the hearing instrument containing the TSG module.

Absolute Hearing Solutions

614-452-4280

15.3.4 Important notice for prospective sound generator users

A tinnitus masker is an electronic device intended to generate noise of sufficient intensity and bandwidth to mask internal noises. It is also used as an aid in hearing external noises and speech.

Good health practice requires that a person with a tinnitus condition have a medical evaluation by a licensed physician (preferably a physician who specializes in diseases of the ear) before using a sound generator. Licensed physicians who specialize in diseases of the ear are often referred to as otolaryngologists, otologists or otorhinolaryngologists.

The purpose of medical evaluation is to assure that all medically treatable conditions that may affect tinnitus are identified and treated before the sound generator instrument is used.

The sound generator instrument is a tool to generate sounds to be used with appropriate counseling and/ or in a tinnitus management program to relieve patients suffering from tinnitus.

15.4 Tinnitus Sound Generator warnings

1. Sound generators can be dangerous if improperly used
2. Sound generators should be used only as advised by your doctor, audiologist, or hearing care professional
3. Sound generators are not toys and should be kept out of reach of anyone who might cause themselves injury (especially children and pets)

6. Audiometric air-bone gap equal to or greater than 15 dB at 500 hertz (Hz), 1,000 Hz, and 2,000 Hz
7. Visible evidence of significant cerumen accumulation or a foreign body in the ear canal
8. Pain or discomfort in the ear.

15.4.1 Tinnitus Sound Generator precautions

1. Should the user develop any side effects from using the sound generator, such as dizziness, nausea, headaches, perceived decrease in auditory function or increase in tinnitus perception, the user should discontinue use of the sound generator and seek medical evaluation
2. To prevent unintended usage by pediatric or physically or mentally disabled users, the volume control must, if enabled, be configured to only provide a decrease of the sound generator output level
3. The volume control is an optional feature in the TSG module used for adjusting the sound generator output level.
4. Children and physically or mentally disabled users will require guardian supervision while wearing the TSG hearing aid.



CAUTION: The maximum output of the sound generator falls into the range that can cause hearing loss according to OSHA regulations. In accordance with NIOSH recommendations, the user should not use the sound generator for more than eight (8) hours a day when set to a level of 85 dB SPL or above. When the sound generator is set to levels of 90 dB SPL or above, the user should not use the sound generator for more than two (2) hours per day. In no case should the sound generator be worn at uncomfortable levels.

15.4.2 Tinnitus Sound Generator warning to hearing care professionals

A hearing care professional should advise a prospective sound generator user to consult promptly with a licensed physician (preferably an ear specialist) before getting a sound generator if the hearing care professional determines through inquiry, actual observation, or review of any other available information concerning the prospective user that the prospective user has any of the following conditions:

1. Visible, congenital or traumatic deformity of the ear
2. History of active drainage from the ear within the previous 90 days
3. History of sudden or rapidly progressive hearing loss within the previous 90 days
4. Acute or chronic dizziness
5. Unilateral hearing loss of sudden or recent onset within the previous 90 days

10. External devices connected to the electrical input must be safe according to the requirements of IEC 60601-1-1, IEC 60065, or IEC 60950-1, as appropriate (wired connection, for example HI-PRO, SpeedLink)

16 General Warnings

1. If a hearing aid is broken, do not use it
2. Consult a hearing care professional if you think there may be a foreign object in your ear canal, if you experience skin irritation, or if excessive earwax accumulates with the use of the hearing aid
3. Different types of radiation, e.g. from NMR, MRI or CT scanners, may damage hearing aids. It is recommended not to wear hearing aids during these or other similar procedures. Other types of radiation, such as burglar alarms, room surveillance systems, radio equipment, mobile telephones, contain less energy and will not damage hearing aids. However, they have the potential to momentarily affect the sound quality or temporarily create undesired sounds from hearing aids
4. Do not wear hearing aids in mines, oil fields, or other explosive areas unless those areas are certified for hearing aid use
5. Do not allow others to use your hearing aids. This may cause damage to the hearing of the other individual or to the hearing aids
6. Hearing aid usage by children or mentally disabled persons should be supervised at all times to ensure their safety. The hearing aid contains small parts that could be swallowed by children. Please be mindful not to leave children unsupervised with this hearing aid
7. Hearing aids should be used only as prescribed by your hearing care professional. Incorrect use may result in sudden and permanent hearing loss
8. Warning to hearing care professionals: Special care should be exercised in selecting and fitting hearing aids with maximum sound pressure level that exceeds 132dB SPL with an IEC 60711:1981 occluded ear simulator. The remaining hearing may risk further impairment.
9. When boarding a flight or entering an area where RF transmitters are prohibited, deactivate wireless functionality. Turn off your wireless functionality by using the flight mode in areas where radio frequency emission is prohibited

17 General precautions - Wireless hearing aids

1. When wireless function is activated, the device uses low-powered digitally coded transmissions in order to communicate with other wireless devices. Although unlikely, nearby electronic devices may be affected. In that case, move the hearing aids away from the affected electronic device
2. When using wireless functionality and the hearing aids are affected by electromagnetic interference, move away from the source of interference
3. For use of wireless functionality only use ReSound wireless accessories. For further guidance, please refer to the User Guide of the relevant wireless accessory.
4. Only connect ReSound hearing aids to ReSound wireless accessories intended and qualified to be used with ReSound hearing aids.

18 Phone Now warnings

1. Keep magnets out of reach of children, mentally disabled persons, and pets.
2. If a magnet is swallowed, please seek immediate advice from a medical practitioner
3. The Phone Now magnet may affect sensitive medical devices / electronic systems. Seek advice from the manufacturers regarding appropriate safety measures when using the Phone Now solution near the sensitive device / equipment (pacemakers and defibrillators) in question.
4. If the manufacturer cannot issue a statement, we recommend keeping the magnet or a telephone equipped with the magnet 30 cm (12”) away from magnetically sensitive devices (e.g. pacemakers)

18.1 Phone Now precautions

1. If you experience frequent signal loss or noise during calls, move the Phone Now magnet to another place on the telephone receiver
2. Only use magnets supplied by ReSound

19 Battery warnings

Batteries contain dangerous substances and should be disposed of carefully in the interest of your safety and for the environment. Please note:

1. Keep batteries away from children, mentally disabled persons, and pets
2. DO NOT place batteries in your mouth
3. Consult a physician immediately if a battery has been swallowed, as they can be harmful to your health
4. Do not recharge Zinc-Air batteries - they may leak or explode
5. DO NOT attempt to dispose of batteries by burning them
6. Used batteries are harmful to the environment. Please dispose of them according to local regulations or return them to your hearing care professional
7. Remove the batteries to prevent leakage when the hearing aids are not in use for an extended period of time.
8. If the batteries are not inserted correctly, the device will not work and the batteries may build up heat. If this happens, please remove the batteries.

20 Intended use of smartphone apps

The app must only be used with ReSound hearing aids for which they are intended, and ReSound takes no responsibility if the app is used with other hearing aids.

21  Important points for FM

1. Do not use two transmitters on the same FM channel
2. Do not use water or fluids for cleaning the FM receiver
3. Do not use an FM transmitter in locations where it is forbidden to use electronic devices, for instance in airplanes
4. Be aware that FM signals might also be picked up and overheard by other receivers
5. Before using the system in another country, contact your hearing care professional to make sure your radio channel is permitted in that country
6. Your FM receiver and FM transmitter may only be repaired by an authorized service center

22  Warning to hearing aid professionals (US only)

A hearing care professional should advise a prospective hearing aid user to consult promptly with a licensed physician (preferably an ear specialist) before dispensing a hearing aid if the hearing care professional determines through inquiry, actual observation, or review of any other available information concerning the prospective user, that the prospective user has any of the following conditions:

1. Visible congenital or traumatic deformity of the ear
2. History of active drainage from the ear within the previous 90 days
3. History of sudden or rapidly progressive hearing loss within the previous 90 days
4. Acute or chronic dizziness
5. Unilateral hearing loss of sudden or recent onset within the previous 90 days
6. Audiometric air-bone gap equal to or greater than 15 decibels at 500 hertz (Hz), 1,000 Hz, and 2,000 Hz
7. Visible evidence of significant cerumen accumulation or a foreign body in the ear canal
8. Pain or discomfort in the ear.

23 Important notice for prospective hearing aid users (US only)

Good health practice requires that a person with a hearing loss have a medical evaluation by a licensed physician (preferably a physician who specializes in diseases of the ear) before purchasing a hearing aid. Licensed physicians who specialize in diseases of the ear are often referred to as otolaryngologists, otologists or otorhinolaryngologists. The purpose of medical evaluation is to assure that all medically treatable conditions that may affect hearing are identified and treated before the hearing aid is purchased.

Following the medical evaluation, the physician will give you a written statement that states that your hearing loss has been medically evaluated and that you may be considered a candidate for a hearing aid. The physician will refer you to an audiologist or a hearing care professional, as appropriate, for a hearing aid evaluation.

The audiologist or hearing care professional will conduct a hearing aid evaluation to assess your ability to hear with and without a hearing aid. The hearing aid evaluation will enable the audiologist or hearing care professional to select and fit a hearing aid to your individual needs.

If you have reservations about your ability to adapt to amplification, you should inquire about the availability of a trial-rental or purchase-option program. Many hearing care professionals now offer programs that permit you to wear a hearing aid for a period of time for a nominal fee after which you may decide if you want to purchase the hearing aid.

Federal law restricts the sale of hearing aids to those individuals who have obtained a medical evaluation from a licensed physician. Federal law permits a fully informed adult to sign a waiver statement declining the medical evaluation for religious or personal beliefs that preclude consultation with a physician. The exercise of such a waiver is not in your best health interest and its use is strongly discouraged.

23.1 Children with hearing loss (US only)

In addition to seeing a physician for a medical evaluation, a child with a hearing loss should be directed to an audiologist for evaluation and rehabilitation because hearing loss may cause problems in language development and the educational and social growth of a child. An audiologist is qualified by training and experience to assist in the evaluation and rehabilitation of a child with hearing loss.

24 Technical specifications

Models: ET 88-DWH

Reference test gain (60 dB SPL input)	HFA	52	dB
Full-on gain (50 dB SPL input)	HFA	73 68	dB
Maximum output (90 dB SPL input)	HFA	132 129	dB SPL
Total harmonic distortion		500 Hz 0.8 800 Hz 0.6 1,600 Hz 0.4	%
HFA-SPLIV Telecoil sensitivity @ 31.6 mA/m(ANSI)	HFA	112	dB SPL
Equivalent input noise		23	dB SPL
Frequency range (DIN 45605/ANSI)		100-4,740	Hz
Current drain		1.2/1.4	mA

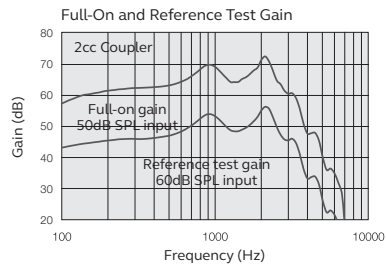
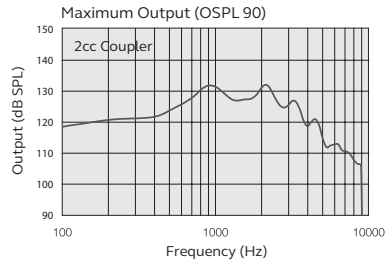

Absolute Hearing Solutions
614-452-4280

Models: ET 98-DW

Reference test gain (60 dB SPL input)	HFA	54	dB
Full-on gain (50 dB SPL input)	HFA	83 69	dB
Maximum output (90 dB SPL input)	HFA	141 131	dB SPL
Total harmonic distortion		500 Hz 4.0 800 Hz 0.7 1,600 Hz 0.9	%
HFA-SPLIV Telecoil sensitivity @ 31.6 mA/m(ANSI)	HFA	116	dB SPL
Equivalent input noise		26	dB SPL
Frequency range (DIN 45605/ANSI)		100-5,860	Hz
Current drain		1.3/3.3	mA

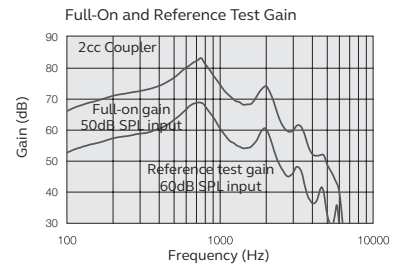
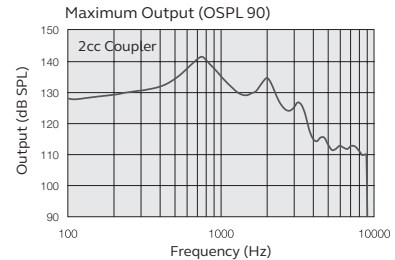

25 Troubleshooting guide

SYMPTOM	CAUSE	POSSIBLE REMEDY
Feedback, “whistling”	Is your earmold or dome inserted correctly?	Put it in again.
	Is the volume very loud?	Reduce it.
	Is the plastic tube or the earmold clogged or broken?	Replace or visit your hearing care professional.
	Are you holding an object (e.g. a hat, a telephone receiver) close to a hearing aid?	Move your hand away to create more space between the hearing aid and the object.
	Is your ear full of wax?	Visit your physician.
No sound	Is the hearing aid turned on?	Switch it on.
	Is the hearing aid in telecoil mode?	Switch to the microphone program.
	Is there a battery in the hearing aid?	Insert a new battery.
	Is the battery still good?	Insert a new battery.
	Is the plastic tube or the earmold clogged or broken?	Clean it or replace with a new one.
	Is your ear full of wax?	Visit your hearing care professional.

Absolute Hearing Solutions

614-452-4280

SYMPTOM	CAUSE	POSSIBLE REMEDY
Sound is distorted, spluttering or weak?	Is the battery dead?	Replace it with a new one.
	Is the battery dirty?	Clean it or replace it with a new one.
	Is the battery old?	Replace it with a new one.
	Is the plastic tube or the earmold clogged or broken?	Visit your hearing care professional.
	Did your hearing aid get moist?	Use a desiccant.
Battery drains very quickly	Did you leave your hearing aid switched on for long periods of time?	Always switch off your hearing aid when you are not using them, e.g. during the night.
	Is the battery old?	Check the date on the battery packaging.

Always switch off your hearing aids when you are not using them, e.g. during the night. Check the date on the battery packaging.

26 Statement

This device complies with part 15 of the FCC rules and ISED rules. Operation is subject to the following two conditions:

1. This device may not cause harmful interference
2. This device must accept any interference received, including interference that may cause undesired operation



NOTE: This equipment has been tested and found to comply with the limits for a Class B digital device, pursuant to part 15 of the FCC rules and ISED rules. These limits are designed to provide reasonable protection against harmful interference in a residential installation. This equipment generates, uses and can radiate radio frequency energy and, if not installed and used in accordance with the instructions, may cause harmful interference to radio communications. However, there is no guarantee that interference will not occur in a particular installation. If this equipment does cause harmful interference to radio or television reception, which can be determined by turning the equipment off and on, the user is encouraged to try to correct the interference by one or more of the following measures:

- Reorient or relocate the receiving antenna
- Increase the separation between the equipment and receiver
- Connect the equipment into an outlet on a circuit different from the one in which the receiver is connected
- Consult the dealer or an experienced radio/TV technician for help
- Changes or modifications can void the user's authority to operate the equipment.

Absolute Hearing Solutions

614-452-4280 The products are in compliance with the following regulatory requirements:

- In EU: the device conforms to the Essential Requirements according to Annex I of Council Directive 93/42/EEC for medical devices (MDD).
- Hereby, GN ReSound A/S declares that the radio equipment types LO85 and LO90 are in compliance with Directive 2014/53/EU. The full text of the EU declaration of conformity is available at the following internet address: www.declarations.resound.com
- In US: FCC CFR 47 Part 15, subpart C.
- Other identified applicable international regulatory requirements in countries outside the US. Please refer to local country requirements for these areas.
- In Canada: these hearing aids are certified under the rules of ISED.

This device operates in the frequency range of 2.4 GHz - 2.48 GHz.

This device includes an RF transmitter that operates in the range of 2.4 GHz - 2.48 GHz.

Nominal RF output power transmitted is 0 dBm.

Behind-the-Ear (BTE) hearing aids type **LO85** with FCC ID X26LO85, IC number 6941C-LO85 and size 13 battery are available in following variants:

ET988-DWH ET788-DWH ET588-DWH

Super Power Behind-the-Ear (SP BTE) hearing aids type **LO90** with FCC ID X26LO90, IC number 6941C-LO90 and size 675 battery are available in the following variants:

ET998-DW ET798-DW ET598-DW

The identification number for the mentioned device models can be found behind the battery door as indicated in the illustrations on page 8 - 9.

27 Warranties and repairs

ReSound provides a warranty on hearing aids in the event of defects in workmanship or materials, as described in applicable warranty documentation. In its service policy, ReSound pledges to secure functionality at least equivalent to the original hearing aid. As a signatory to the United Nations Global Compact initiative, ReSound is committed to doing this in line with environment-friendly best practices. Hearing aids therefore, at ReSound's discretion, may be replaced by new products or products manufactured from new or serviceable used parts, or repaired using new or refurbished replacement parts. The warranty period of hearing aids is designated on your warranty card, which is provided by your hearing care professional.

For hearing aids that require service, please contact your hearing care professional for assistance. ReSound hearing aids that malfunction must be repaired by a qualified technician. Do not attempt to open the case of hearing aids, as this will invalidate the warranty.

28 Temperature test, transport, and storage information

ReSound hearing aids are subjected to various tests in temperature and damp heating cycling between -13°F and 158°F according to internal and industry standards.

During transport or storage, the temperature should not exceed the limit values of -4°F and 140°F and relative humidity of 90% RH, non-condensing (for limited time). The air pressure between 500 hPa and 1,100 hPa is appropriate.



ReSound ENZO 3D is compatible with iPhone 8 Plus, iPhone 8, iPhone 7 Plus, iPhone 7, iPhone 6s Plus, iPhone 6s, iPhone 6 Plus, iPhone 6, iPhone SE, iPhone 5s, iPhone 5c, iPhone 5, iPad Pro (10.5-inch), iPad Pro (12.9-inch), iPad Pro (9.7-inch), iPad Air 2, iPad Air, iPad mini 4, iPad mini 3, iPad mini 2, iPad mini, iPad (5th generation), iPad (4th generation), iPod touch (6th generation) and iPod touch (5th generation) using iOS 8.0 or later. Apple, the Apple logo, iPhone, iPad Pro, iPad Air, iPad mini, iPad and iPod touch are trademarks of Apple Inc., registered in the U.S. and other countries.

© 2017 GN Hearing A/S. All rights reserved. ReSound is a trademark of GN Hearing A/S. Apple, the Apple logo, iPhone, iPad Pro, iPad Air, iPad mini, iPad and iPod touch are trademarks of Apple Inc., registered in the U.S. and other countries. Android is a trademarks of Google Inc. The Bluetooth word mark and logos are registered trademarks owned by the Bluetooth SIG, Inc.

 “Made for iPod/iPhone/iPad” means that an electronic accessory has been designed to connect to iPhone, iPad, and iPod models and has been certified by the developer to meet Apple performance standards. Apple is not responsible for the operation of this device or its compliance with safety and regulatory standards. Please note that the use of this accessory with iPhone, iPad or iPod may affect wireless performance.

Absolute Hearing Solutions

614-452-4280

29 Advisories

The Advisories contain important information which must be fully understood, shared and followed at all times.

Non-compliance may lead to severe personal injuries and/or equipment damages.

Be aware of information marked with the following symbols:



WARNING points out a situation that could lead to serious injuries.



CAUTION indicates a situation that could lead to minor and moderate injuries.



Advice and tips on how to handle your hearing aid better.



Equipment includes RF transmitter



Please ask your local hearing care professional concerning disposal of your hearing aid.



Please ask your local hearing care professional concerning disposal of your hearing aid.



30 Acknowledgments

Portions of this software are written by Kenneth MacKay (micro-ecc) and licensed under the following terms and conditions:

Copyright (c) 2014, Kenneth MacKay
All rights reserved.

Redistribution and use in source and binary forms, with or without modification, are permitted provided that the following conditions are met:

- Redistributions of source code must retain the above copyright notice, this list of conditions and the following disclaimer
- Redistributions in binary form must reproduce the above copyright notice, this list of conditions and the following disclaimer in the documentation and/or other materials provided with the distribution.

THIS SOFTWARE IS PROVIDED BY THE COPYRIGHT HOLDERS AND CONTRIBUTORS "AS IS" AND ANY EXPRESS OR IMPLIED WARRANTIES, INCLUDING, BUT NOT LIMITED TO, THE IMPLIED WARRANTIES OF MERCHANTABILITY AND FITNESS FOR A PARTICULAR PURPOSE ARE DISCLAIMED. IN NO EVENT SHALL THE COPYRIGHT HOLDER OR CONTRIBUTORS BE LIABLE FOR ANY DIRECT, INDIRECT, INCIDENTAL, SPECIAL, EXEMPLARY, OR CONSEQUENTIAL DAMAGES (INCLUDING, BUT NOT LIMITED TO, PROCUREMENT OF SUBSTITUTE GOODS OR SERVICES; LOSS OF USE,

DATA, OR PROFITS; OR BUSINESS INTERRUPTION) HOWEVER CAUSED AND ON ANY THEORY OF LIABILITY, WHETHER IN CONTRACT, STRICT LIABILITY, OR TORT (INCLUDING NEGLIGENCE OR OTHERWISE) ARISING IN ANY WAY OUT OF THE USE OF THIS SOFTWARE, EVEN IF ADVISED OF THE POSSIBILITY OF SUCH DAMAGE.

Absolute Hearing Solutions

614-452-4280

Manufacturer according to
EU Medical Device
Directive 93/42/EEC:

GN ReSound A/S
Lautrupbjerg 7
DK-2750 Ballerup
Denmark
Tel.: +45 4575 1111
resound.com

CVR no. 55082715

Manufacturer according
to FDA:

GN ReSound North America
8001 E Bloomington Freeway
Bloomington, MN 55420
USA
1-888-735-4327
resound.com

Manufacturer according to
Health Canada:

ReSound Canada
2 East Beaver Creek Road, Building 3
Richmond Hill, ON L4B 2N3
Canada
1-888-737-6863
resound.com



Absolute Hearing Solutions LLC
absolutehearing@att.net

750 Cross Pointe Road Suite F
Gahanna, Ohio 43230

Phone: 614-452-4280
Toll Free: 888-803-2159
Fax: 614-577-0481
www.absolutehearingsolutions.com



Any issues relating to the EU Medical Device Directive 93/42/EEC or EU Radio
Equipment Directive 2014/53/EU should be directed to GN ReSound A/S.

ReSound GN